

Laboratory Safety and Work Instructions

Attention Student! Read the following carefully because your instructor may give you a quiz on this material.

The laboratory can be—but is not necessarily—a dangerous place. When intelligent precautions and a proper understanding of techniques are employed, the laboratory is no more dangerous than any other classroom. Most of the precautions are just common-sense practices. These include the following:

1. Wear *approved* eye protection (including splash guards) at all times while in the laboratory. (*No one will be admitted without it.*) Your safety eye protection may be slightly different from that shown, but it must include shatterproof lenses and side shields to provide protection from splashes.

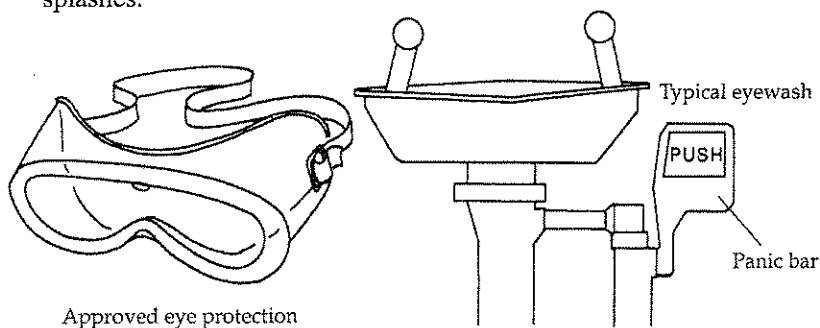

The laboratory has an eyewash fountain available for your use. In the event that a chemical splashes near your eyes, you should use the fountain *before the material runs behind your eyeglasses and into your eyes*. The eyewash has a "panic bar," which enables its easy activation in an emergency.

2. Wear shoes at all times. (*No one will be admitted without them.*)
3. Eating, drinking, and smoking are strictly prohibited in the laboratory at all times.
4. Know where to find and how to use all safety and first-aid equipment (see the first page of this book).
5. Consider all chemicals to be hazardous unless you are instructed otherwise. *Dispose of chemicals as directed by your instructor.* Follow the explicit instructions given in the experiments.

LABORATORY SAFETY

6. If chemicals come into contact with your skin or eyes, wash immediately with copious amounts of water and then consult your laboratory instructor.
7. Never taste anything. Never directly smell the source of any vapor or gas. Instead, by means of your cupped hand, bring a small sample to your nose. Chemicals are not to be used to obtain a “high” or clear your sinuses.

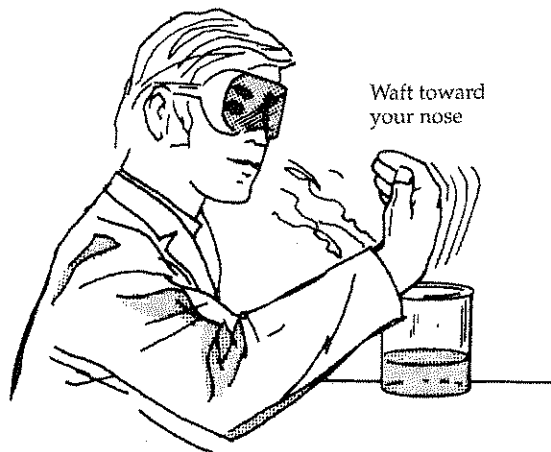

8. Perform in the fume exhaust hood any reactions involving skin-irritating or dangerous chemicals, or unpleasant odors. This is a typical fume exhaust hood. Exhaust hoods have fans to exhaust fumes out of the hood and

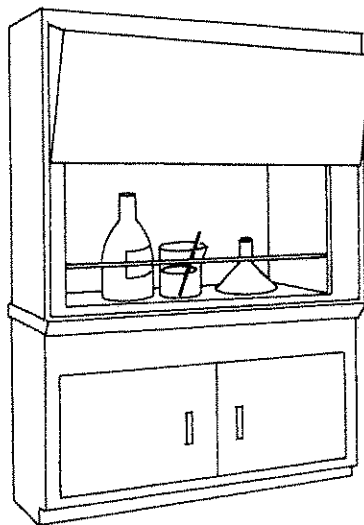

away from the user. The hood should be used when you are studying noxious, hazardous, and flammable materials. It also has a shatterproof glass window, which may be used as a shield to protect you from minor explosions. Reagents that evolve toxic fumes are stored in the hood. Return these reagents to the hood after their use.

9. Never point a test tube that you are heating at yourself or your neighbor—it may erupt like a geysir.



10. Do not perform *any* unauthorized experiments.
11. Clean up all broken glassware *immediately*.
12. Always pour acids into water, not water into acid, because the heat of solution will cause the water to boil and the acid to spatter. "Do as you oughter, pour acid into water."
13. Avoid rubbing your eyes unless you *know* that your hands are clean.
14. When inserting glass tubing or thermometers into stoppers, *lubricate the tubing and the hole in the stopper with glycerol or water*. Wrap the rod in a towel and grasp it as close to the end being inserted as possible. Slide the glass into the rubber stopper with a twisting motion. Do not push. Finally, remove the excess lubricant by wiping with a towel. Keep your hands as close together as possible in order to reduce leverage.

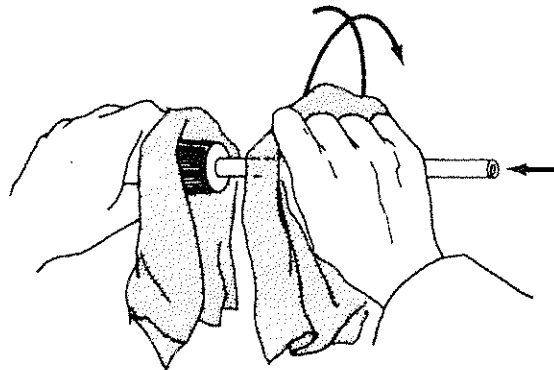

15. For safety purposes, always place the ring stand as far back on the laboratory bench as comfortable, with the long edges of the base perpendicular to the front of the bench.

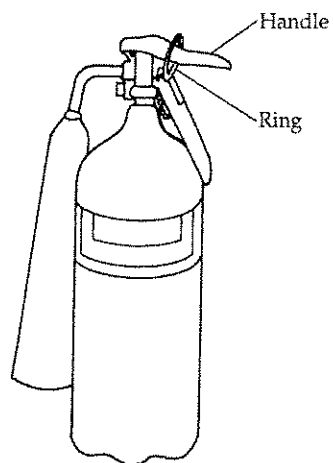
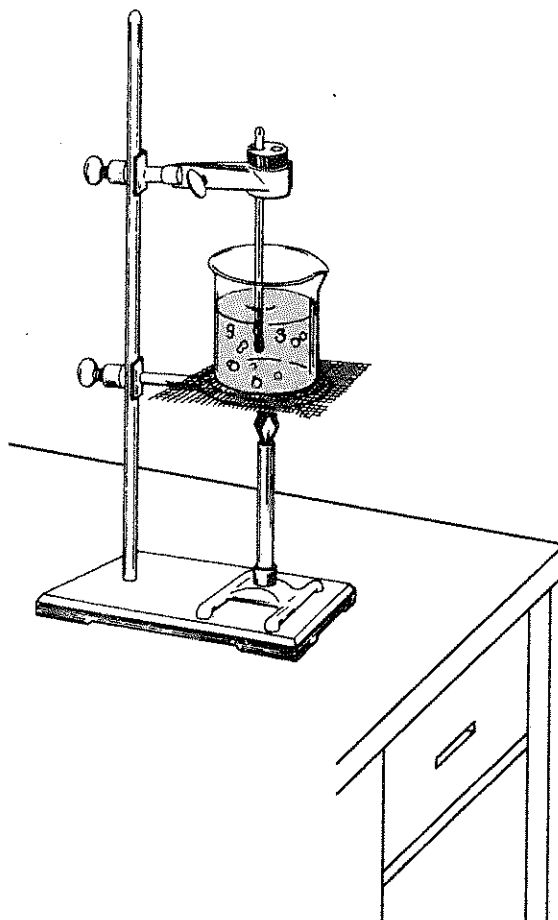

16. NOTIFY THE INSTRUCTOR IMMEDIATELY IN CASE OF AN ACCIDENT.
17. Many common reagents—for example, alcohols, acetone, and especially ether—are highly flammable. *Do not use them anywhere near open flames.*
18. Observe all special precautions mentioned in experiments.
19. Learn the location and operation of fire-protection devices.

In the unlikely event that a large chemical fire occurs, carbon dioxide fire extinguishers are available in the lab (usually mounted near one of the exits in the room). A typical carbon dioxide fire extinguisher is shown above.

In order to activate the extinguisher, you must pull the metal safety ring from the handle and then depress the handle. Direct the output from the extinguisher at the base of the flames. The carbon dioxide smothers the flames and cools the flammable material quickly. If you use the fire extinguisher, be sure to turn the extinguisher in at the stockroom so that it can be refilled immediately. If the carbon dioxide extinguisher does not extinguish the fire, evacuate the laboratory immediately and call the fire department.

One of the most frightening and potentially most serious accidents is the ignition of one's clothing. Certain types of clothing are hazardous in the laboratory and must *not* be worn. Since *sleeves* are most likely to come closest to flames, **ANY CLOTHING THAT HAS BULKY OR LOOSE SLEEVES SHOULD NOT BE WORN IN THE LABORATORY.** Ideally, students should wear laboratory coats with tightly fitting sleeves. Long hair also presents a hazard and must be tied back.

If a student's clothing or hair catches fire, his or her neighbors should take prompt action to prevent severe burns. Most laboratories have a water shower for such emergencies. A typical laboratory emergency water shower has the following appearance:

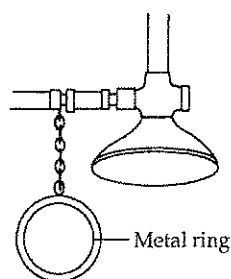

In case someone's clothing or hair is on fire, immediately lead the person to the shower and pull the metal ring. Safety showers generally dump 40 to 50 gallons of water, which should extinguish the flames. These showers generally cannot be shut off once the metal ring has been pulled. Therefore, the shower cannot be demonstrated. (Showers are checked for proper operation on a regular basis, however.)

20. Whenever possible, use hot plates in place of Bunsen burners.

**BASIC
INSTRUCTIONS
FOR LABORATORY
WORK**

1. Read the assignment *before* coming to the laboratory.
2. Work independently unless instructed to do otherwise.
3. Record your results directly onto your report sheet or notebook. **DO NOT RECOPY FROM ANOTHER PIECE OF PAPER.**
4. Work conscientiously to avoid accidents.
5. Dispose of excess reagents as instructed by your instructor. **NEVER RETURN REAGENTS TO THE REAGENT BOTTLE.**
6. Do not place reagent-bottle stoppers on the desk; hold them in your hand. Your laboratory instructor will show you how to do this. Replace the stopper on the same bottle, never on a different one.
7. Leave reagent bottles on the shelf where you found them.
8. Use only the amount of reagent called for; avoid excesses.
9. Whenever instructed to use water in these experiments, use distilled water unless instructed to do otherwise.
10. Keep your area clean.
11. Do not borrow apparatus from other desks. If you need extra equipment, obtain it from the stockroom.
12. When weighing, do not place chemicals directly on the balance.
13. Do not weigh hot or warm objects. Objects should be at room temperature.
14. Do not put hot objects on the desktop. Place them on a wire gauze or heat-resistant pad.

“I have read and understand these instructions as well as the laboratory safety and work instructions”

Student Signature

Date